

REVISION HISTORY			
REV	DESCRIPTION	DATE	APPROVED

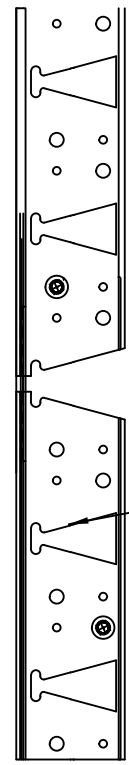

Udstansninger i fod-profil giver øget fleksibilitet

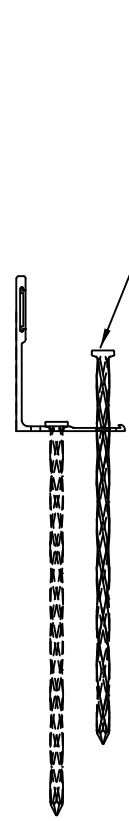
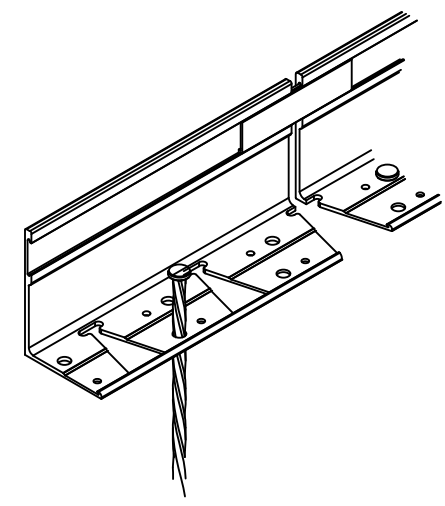

Skal fastgøres med spyd. Der anbefales 3 spyd pr. mtr

VIGTIG! Når AluExcel bruges i forbindelse med en varm belægning såsom asfalt, skal der være 8-10mm luft i samlingerne.

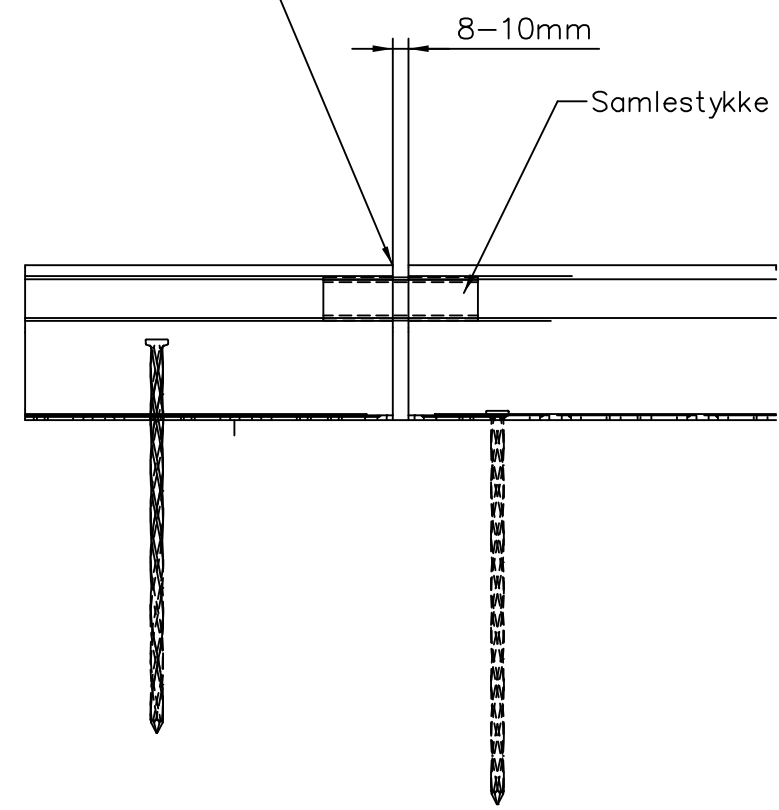

REVISION HISTORY			
REV	DESCRIPTION	DATE	APPROVED

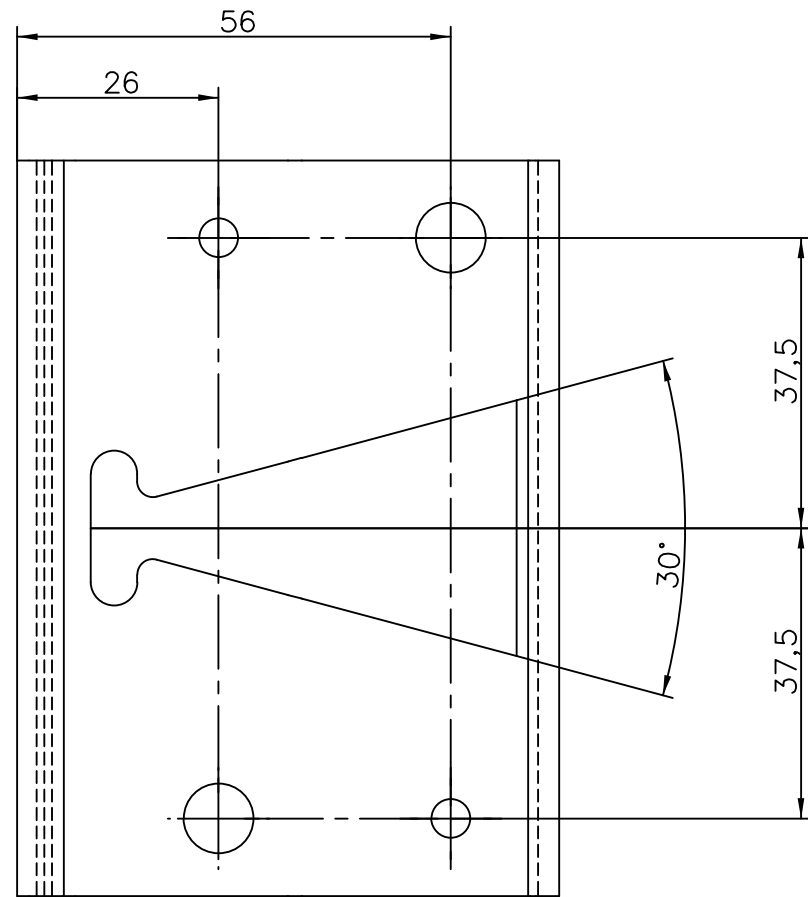

XLAE100L

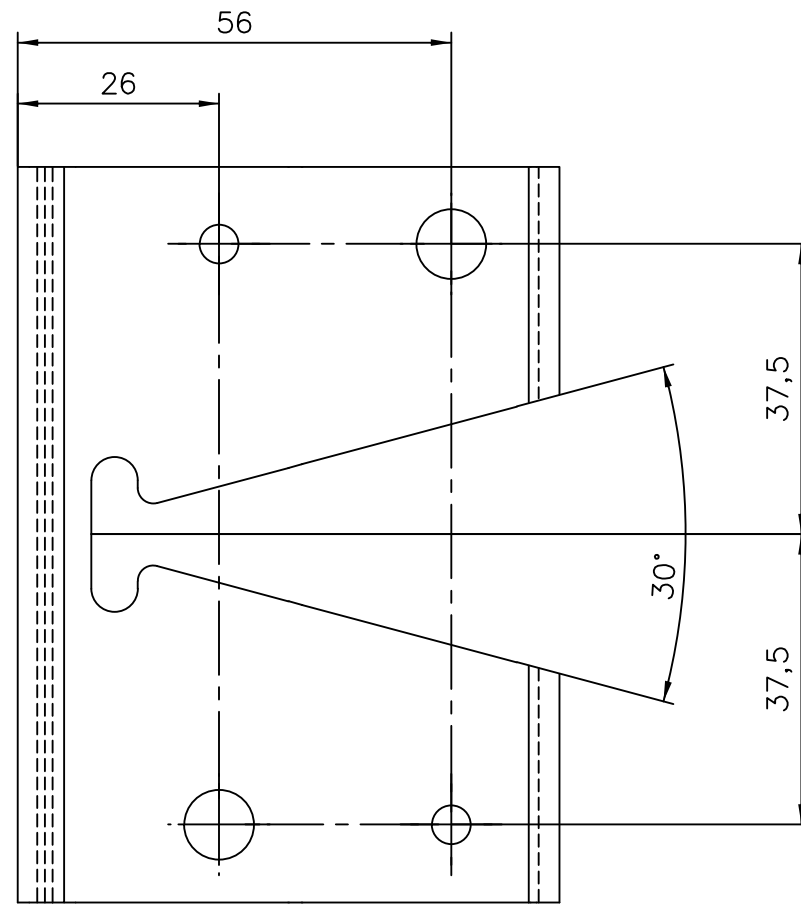

XLAE100M

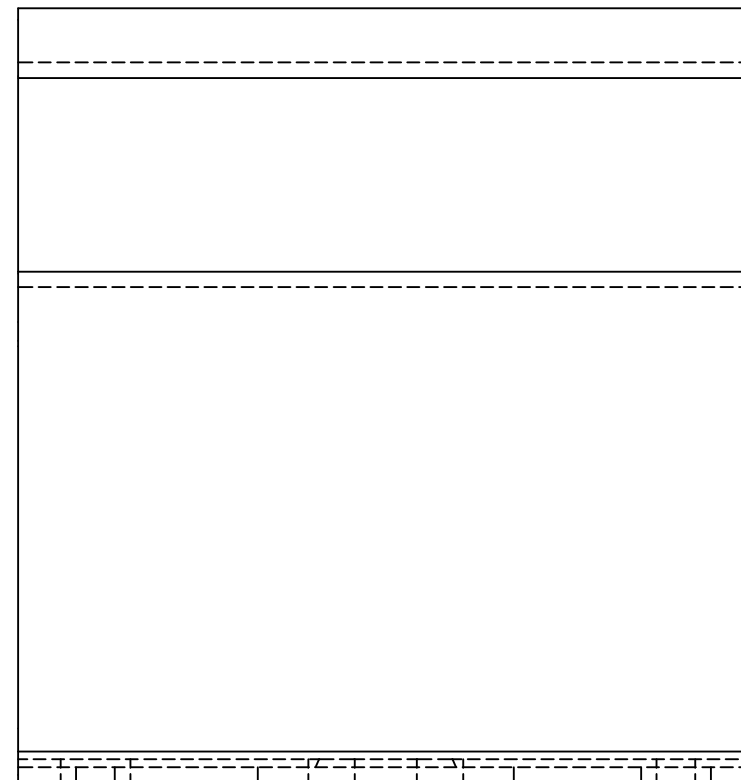
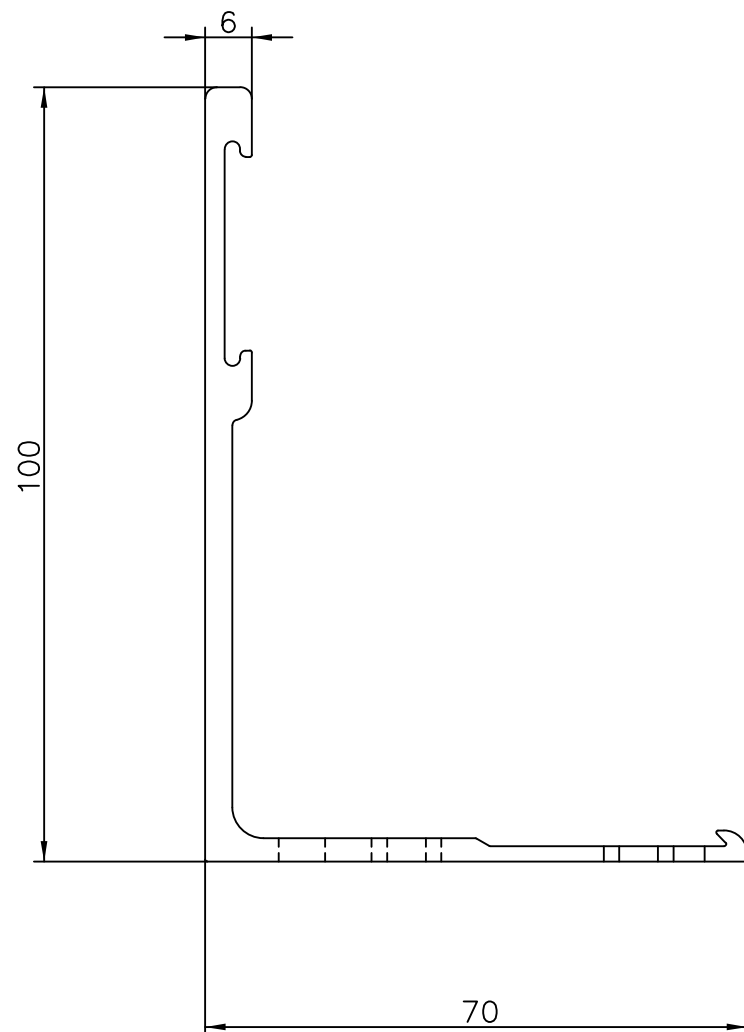

AluExcel XLAE100M/XLAE100L
Kantafgrænsning i aluminium

Milford P/S
Walgerholm 13-15
Tel +45 44971099
www.milford.dk